

CPHD-3

HDMI/PC/Audio Generator and Analyzer



Operation Manual

SAFETY PRECAUTIONS

Please read all instructions before attempting to unpack, install or operate this equipment and before connecting the power supply.

Please keep the following in mind as you unpack and install this equipment:

- Always follow basic safety precautions to reduce the risk of fire, electrical shock and injury to persons.
- To prevent fire or shock hazard, do not expose the unit to rain, moisture or install this product near water.
- Never spill liquid of any kind on or into this product.
- Never push an object of any kind into this product through any openings or empty slots in the unit, as you may damage parts inside the unit.
- Do not attach the power supply cabling to building surfaces.
- Use only the supplied power supply unit (PSU). Do not use the PSU if it is damaged.
- Do not allow anything to rest on the power cabling or allow any weight to be placed upon it or any person walk on it.
- To protect the unit from overheating, do not block any vents or openings in the unit housing that provide ventilation and allow for sufficient space for air to circulate around the unit.

REVISION HISTORY

VERSION NO.	DATE DD/MM/YY	SUMMARY OF CHANGE
VS1	01/11/12	First Release

CONTENTS

1. Introduction	1
2. Applications	1
3. Package Contents	1
4. System Requirements	1
5. Features	2
6. Operation Controls and Functions	3
6.1 Front Panel	3
6.2 Rear Panel.....	5
6.3 Remote Control.....	7
6.4 Dip Switch Control Setting.....	8
6.5 Built-In RX EDID	8
6.6 RS-232 Protocols	9
6.7 RS-232 PC Software.....	13
6.8 Firmware Revision History.....	14
6.9 Timings Table.....	15
6.10 Patterns Table	16
6.11 Patterns Description	17
7. Connection Diagram	25
8. Specifications	26
9. Acronyms	31

1. INTRODUCTION

The HDMI/PC/Audio Generator and Analyzer is an advanced device for testing your audio and video signals. It boasts HDMI, Optical and 7.1 Analog inputs and outputs as well as a PC/HD and Coaxial output. With 39 built in resolution timings and 51 test patterns for testing both analog and digital signals, this pattern generator provides over a thousand types of test patterns. HDCP and EDID data can be analyzed to confirm configurations and provide test data for complex HD systems. This device can be controlled via the front panel buttons or through the IR remote and results viewed on the LCM.

2. APPLICATIONS

- HD Installer/integrator multi-function RS-232 tool
- Source and display testing
- HD System error identification
- Third-party equipment setup
- Source and Sink EDID reading
- Defining source settings
- HDCP verification
- Production testing
- R&D design and testing

3. PACKAGE CONTENTS

- 1×HDMI/PC/Audio Generator and Analyzer
- 1×Power Adaptor
- 1×Remote Control
- Operation Manual

4. SYSTEM REQUIREMENTS

- The pattern generator requires video and/or audio input sources with connecting cables and output display and/or speaker(s) with connecting cables.
- RS-232 PC Application (downloadable from www.cypress.com.tw)

5. FEATURES

- HDMI, HDCP 1.1 and DVI 1.0 compliant
- Provides 39 resolution timings and 51 test patterns
- Timings include SD, HD up to 1080p, PC up to UXGA/WUXGA (Reduced Blanking Pixel Rate at 154 MHz)
- Graphic Tests and Data Analysis patterns included
- Outputs HDMI/DVI, or analog PC/HD (component)
- Supported color formats include RGB444, YCbCr444 and YCbCr422
- Deep color support up to 8/10/12-bit
- Selectable audio source from analog 7.1CH, optical or internal sine wave generator
- Internal sinewave LPCM channel is selectable from 2CH, 5.1CH and 7.1CH
- Supports the following tests and analysis: HDCP, EDID, HDMI/DVI
- Has an Auto-run setting
- Choose between different timings and patterns through RS-232 commands using the easily downloadable software* and a user friendly interface that utilizes the LCM, LED indicators, IR remote and RS-232 remote commands

*Downloadable from www.cypress.com.tw

6. OPERATION CONTROLS AND FUNCTIONS

6.1 Front Panel

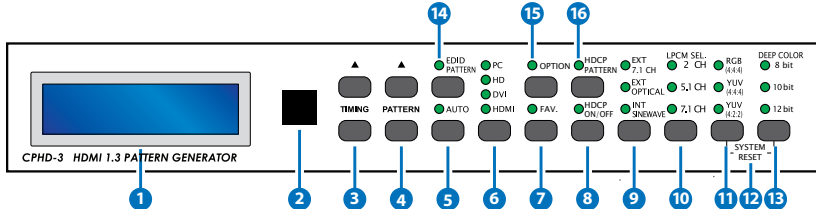

1 LCM:

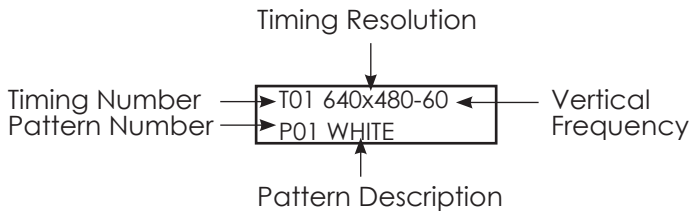

2 IR Remote Control Sensor

3 **TIMING** ▲/▼: Switch between timings from T01 to T39.

4 **PATTERN** ▲/▼: Switch between patterns from P01 to P51. Some patterns have the ability to select different options. After entering an option the user simply has to touch the Pattern button to adjust the value up or down.

5 **AUTO**: Turn ON/OFF Auto-run Demonstration Function.

Using the RS-232 PC software, users can select timings from T01-T39 and patterns among P01-P51 for an Auto run demonstration. When Auto-run mode is turned on, the unit will automatically run the selected timings/patterns in sequential order.

6 **Output Format Selection**: Press the button to switch between PC, HD, DVI and HDMI output options.

7 **FAV.:** Turn ON/OFF Favorite Function.

When favorites function is turned on, users will only be able to select the pre-defined favorite timings and patterns. Users can set their favorite timings from T01-T39 and favorite patterns from

P01-P51 with the RS-232 PC software. When the favorites function is turned off users have access to all timings and patterns.

- 8 **HDCP ON/OFF:** Turn ON/OFF HDCP encryption. When the LED is on, the HDCP encryption is working correctly.
- 9 **Audio Source Selection:** Press the button to switch between External 7.1CH (analog), external optical (digital) or internal sinewave audio sources.
- 10 **LPCM Channel Selection:** Press the button to switch between 2CH, 5.1CH or 7.1CH LPCM audio channels.
- 11 **Color selection:** Press the button to switch between RGB444, YCbCr444 and YCbCr422.
- 12 **SYSTEM RESET:** Press the two buttons simultaneously to reset the system back to the factory default. While the system is resetting, the LCM will show "SYSTEM RESET".
- 13 **DEEP COLOR Selection:** Press the button to switch between 8-bit, 10-bit or 12-bit Deep Color settings.
- 14 **EDID PATTERN:** Pattern 32 hot key.
- 15 **OPTION:** Not all the test patterns are adjustable, when the screen shows "Press (Option) to do setting" that indicates that this pattern supports adjustments. Press the OPTION button, the LED will come on, then press Pattern ▲/▼ buttons to adjust the value.

Note: Turn off the option function before moving to the next pattern.

- 16 **HDCP PATTERN:** Pattern 39 hot key.

6.2 Rear Panel

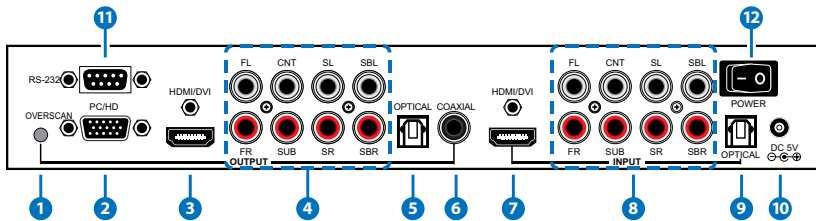

- 1 OVERSCAN:** When output timing is 480i59/60,480p59/60, 576i50 or 576p50, the output signal may not show a full image on the screen, press the OVERSCAN button to have the image fill the screen.
When the signal is in OVERSCAN mode, the LCM will show an asterisk (*) at the end of the timing resolution string. Press OVERSCAN again to turn off the overscan mode and the asterisk (*) will disappear.
- 2 PC/HD Output:** Connect with a VGA cable to a VGA monitor for analog PC timing or with a VGA to Component cable for HD timing signal output.
- 3 HDMI/DVI Output:** Connect with HDMI or HDMI to DVI cable to the HDMI or DVI display.
- 4 7.1CH Output:** 7.1 Multi-channel Analog audio output. Connect to active speakers or AV Receiver. Abbreviations are defined as below:
FL:Front Left, FR:Front Right, CNT:Center, SUB:Subwoofer,SL:Surround Left, SR:Surround Right, SBL:Surround Back Left, SBR:Surround Back Right.
- 5 OPTICAL Output:** Connect the optical digital audio output of the device to the audio equipment's optical input with optical fiber cable.
- 6 COAXIAL Output:** Connect the coaxial digital audio output of the device to the audio equipment's coaxial input with coaxial cable.
- 7 HDMI/DVI Input:** Connect an HDMI or DVI input source to the system.
- 8 7.1CH Input:** Connect 7.1 Multi-channel Analog audio Inputs.
- 9 OPTICAL Input:** Connect an optical digital input source to the system.

- 10 **DC 5V:** Plug the 5V DC power supply into the system and connect the adaptor to an AC outlet.
- 11 **RS-232:** This is the slot where you connect the RS-232 cable from the device to the computer. You can control this device through the RS-232 port and the RS-232 PC software.
- 12 **POWER Switch:** Turns the system ON/OFF.

6.3 Remote Control

- 1 **HDCP ON/OFF:** Turns the HDCP encryption ON/OFF.
 - 2 **COLOR SPACE Selection:** Switch between RGB444, YCbCr444 or YCbCr422.
 - 3 **Output Timing Selection:** Direct selection of common output timings.
 - 4 **OUTPUT ON:** Turn ON the output signal.
 - 5 **TIMING - :** Previous Timing Selection..
 - 6 **AVMUTE ENABLE:** For the HDMI output, press to mute the Video / Audio. The LCM will show "AVMUTE ON".
 - 7 **AUDIO SOURCE:** Switch between External 7.1CH(analog), external optical (digital) or internal sinewave audio sources.
 - 8 **EDID:** Pattern 32 hot key.
 - 9 **OUTPUT FORMAT Selection:** Switch between PC, HD, DVI or HDMI outputs.
 - 10 **OUTPUT OFF:** Switches off the output signal. The LCM will show "OUTPUT OFF".
 - 11 **PATTERN +:** Next Pattern Selection. Some patterns have an optional function. After entering into options, adjust the value using the up/down arrows keys.
 - 12 **TIMING +:**Next Timing Selection.
 - 13 **OK (OPTION):** Not all the test patterns are adjustable, when the screen shows "Press (Option) to do setting" that indicates that this pattern supports adjustments. Press the OPTION(OK) button, the LED will come on, then press Pattern -/+ buttons to adjust the value.
- Note: Turn off the option function before moving to the next pattern.*
- 14 **AVMUTE DISABLE:** For the HDMI output, press to unmute the Video/ Audio.

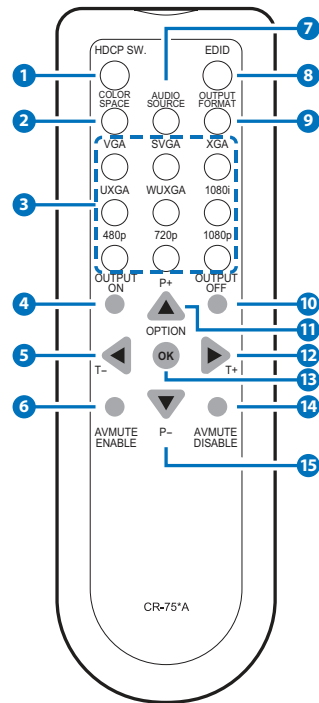

- 15 PATTERN** -: Previous Pattern Selection. Some patterns have OPTION support. Once you enter the option screen, press the Pattern up/down button to adjust the value.

6.4 Dip Switch Control Setting

The remote can control up to four other pattern generators. Select "IR remote address" from the system setup by pushing the pattern buttons on the device's front panel. The "System setup" can be selected after pattern 50 and is not selectable from the remote control. When entering into the "IR remote address" four selections will be available from 0 to 3. It is recommended that each device have a different setting to avoid signal frequency interference. The default factory setting is 0.

IR Remote Address:

The IR remote address can be set using the two DIP switches in the back of the remote, inside the battery cover.

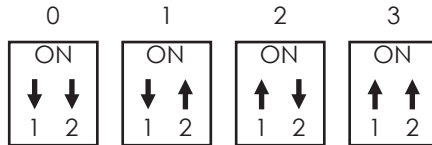

6.5 Built-In RX EDID

- The system has four built-in RX EDID, one is active and others are for backup.
- The Active EDID function will copy the EDID from backup EDID (Go to "System Setup" function).
- The system will copy the Sink EDID and use the built-in RX EDID to analyze and display information.
- Supports EDID programming through the RS-232 PC software.

6.6 RS-232 Protocols

Connection between the unit and remote controller with RS-232 modem cable (No Wire Crossing).

Pin Assignment:

CPHD-3			REMOTE CONTROLLER	
PIN	Definition		PIN	Definition
1	NC		1	NC
2	TxD		2	RxD
3	RxD	→	3	TxD
4	NC	←	4	NC
5	GND		5	GND
6	NC		6	NC
7	NC		7	NC
8	NC		8	NC
9	NC		9	NC

Baud Rate: 19200bps

Data Bit: 8-bit

Parity: None

Stop Bit: 1-bit

Flow Control: None

Command/Response codes of RS-232 transmission:

COMMAND	DESCRIPTION	RESPONSE ¹
ASC001 ASC002 ASC003 ASC999	Audio source is from external L/R Audio source is from external OPTICAL Audio source is from internal Sinewave Inquire audio source status	ASC001 ASC002 ASC003 ASC???
ATO000 ATO001 ATO999 ATN???	Set Auto-run Off Set Auto-run On Inquire Auto-run Action status Auto-run Number, ???=001~032	ATO000 ATO001 ATO??? ATNxxx ²
ATT??? ATP??? ATI??? ATS999	Auto-run Timing, ???=001~039 Auto-run Pattern, ???=001~051 Auto-run time Interval, ???=005~600 seconds Inquire Auto-run Configuration status	ATTxxx ATPxxx ATIxxx ATNxxx + ATTxxx + ...
CRR??? CRG??? CRB??? CRY??? CRR999 CRG999 CRB999 CRY999	Color Setting Red or Cr, ???=000~255 Color Setting Green or Y, ???=000~255 Color Setting Blue or Cb, ???=000~255 Color Setting Gray, ???=000~255 Inquire Color Setting Red or Cr status Inquire Color Setting Green or Y status Inquire Color Setting Blue or Cb status Inquire Color Setting Gray	CRRxxx CRGxxx CRBxxx CRYxxx CRR??*/CRR300 ³ CRG??*/CRG300 CRB??*/CRB300 CRY??*/CRY300
CSC001 CSC002 CSC003 CSC999	Color space is RGB444 Color space is YUV444 Color space is YUV422 Inquire color space status	CSC001 CSC002 CSC003 CSC???
DEE001 DEE002 DEE003 DEE999	Deep Color is 8-bit Deep Color is 10-bit Deep Color is 12-bit Inquire Deep Color status	DEE001 DEE002 DEE003 DEE???
ESC001 ESC002 ESC003 ESC004 ESC005 ESC006	EDID source is from TX (HDMI/DVI out) EDID source is from RX (built-in Active EDID) EDID source is from RX1 (built-in EDID1) EDID source is from RX2 (built-in EDID2) EDID source is from RX3 (built-in EDID3) EDID source is from VGA (PC/HD out)	ESC001 ESC002 ESC003 ESC004 ESC005 ESC006
ERX00? "Name String" ERX99?	Set RX1,RX2 or RX3 EDID name. ?=1~3 EDID name string, string length is 12 byte Inquire RX1,RX2 or RX3 EDID name. ?=1~3	ERX00? ⁴ ERX004 ⁵ ERX99? + "?????????????" ⁶

COMMAND	DESCRIPTION	RESPONSE ¹
ERD001 ERS001 EWR001	Read sink's EDID Erase sink's EDID and fill with 'FF' Write EDID to sink	ERD001, datastream ⁷ ERS001, ERS002/ERS003 ⁸ EWR001, EWR002/EWR003 ⁹
FAV000 FAV001 FAV999	Set My Favorite Off Set My Favorite On Inquire My Favorite action status	FAV000 FAV001 FAV???
FP+??? FP-??? FP+999 or FP-999	Add Favorite PATTERN, ???=001~051 Drop Favorite PATTERN, ???=001~051 Inquire Favorite PATTERN status	FP+xxx FP-xxx FP+??? FP-??? ...
FT+??? FT-??? FT+999 or FT-999	Add Favorite TIMING, ???=001~039 Drop Favorite TIMING, ???=001~039 Inquire Favorite TIMING status	FT+xxx FT-xxx FT+??? FT-??? ...
HDC000 HDC001 HDC999	set HDCP Off set HDCP On Inquire HDCP status	HDC000 HDC001 HDC???
MOT001 "Custom String" MOT999	set Pattern 46.Motion's custom string. Custom string, string length is 12 byte Inquire Motion Pattern's custom string	MOT001 ¹⁰ MOT002 ¹¹ MOT999 + "?????????????" ¹²
OUT001 OUT002 OUT003 OUT004 OUT999	Select output format [PC] Select output format [HD] Select output format [DVI] Select output format [HDMI] Inquire output format status	OUT001 OUT002 OUT003 OUT004 OUT???
PAT??? PAT999	Select PATTERN P01~P50, ???=001~051 Inquire PATTERN status	PATxxx PAT???
PCM001 PCM002 PCM003 PCM999	set LPCM 2CH set LPCM 5.1CH set LPCM 7.1CH Inquire LPCM Channel status	PCM001 PCM002 PCM003 PCM???
RST001	System reset	RST001
TIM??? TIM999	Select TIMING T01~T39, ???=001~039 Inquire TIMING status	TIMxxx TIM???
VER999	Inquire firmware version.	VER???(Ex:VER021=V2.1)

Note:

*1: After the computer sends a command to the system, the computer has to wait for a response from the system. After receiving a command the computer can then send the next command to the system.

If this system is on auto-run, RS-232 communications might fail.

*2: To configure Auto-run users need to follow a sequence of commands ---

ATNxxx + ATTxxx + ATPxxx + ATlxxx ... and ...etc.

*3: If this system is not on Pattern 47 Color Setting, respond CRR300, CRG300, CRB300 or CRY300.

*4: Procedure of setting RX EDID name string :

send "ERX00?" -> wait "ERX00?" response -> send name string (12 bytes) -> wait "ERX004"

*5: In the name string, the rest of the unused bytes (<12bytes) should be filled with 0x00.

*6: After ERX99? response, name string (12 bytes) is followed.

*7: After ERD001 response, this system reads the sink's EDID and transmits them (datastream) to a remote terminal.

If the system reading sink's EDID fails, the system sends '0xfe' and stops the data stream.

This system supports 2-block EDID, datastream
length=block0+block1=256 bytes

*8: After a EWR001 response this system erases sink's EDID and fills it with 'FF'.

After being completely erased, the system responds with ERS002.

If erasing fails, the system responds with ERS003.

*9: After a EWR001 response, this system will wait for EDID data stream (256 bytes) from the PC. After receiving the data stream, the system writes the data stream to sink. If the writing is successful, the system responds with EWR002 or EWR003.

*10: Procedure for setting a custom string :

send "MOT001" -> wait "MOT001" response -> send custom string (12 bytes) -> wait "MOT002"

*11: In the custom string, the rest unused bytes (<12bytes) should be filled with 0x00. Custom string supports English language only.

*12: After MOT999 response, custom string (12 bytes) is followed.

6.7 RS-232 PC Software

- Click button and upload selected timing or pattern
- Select [My Favorite] timings and patterns
- Read out EDID contents from sink
- Write EDID contents to sink
- Can be an EDID burner
- Analyze EDID data and generate a report file
- Configure Auto-run [AUTO] List
- Panel Controls through RS-232
- Monitor System status
- Edit custom string of Motion Pattern (Pattern 46)
- Adjust color-levels pattern (Pattern 47)

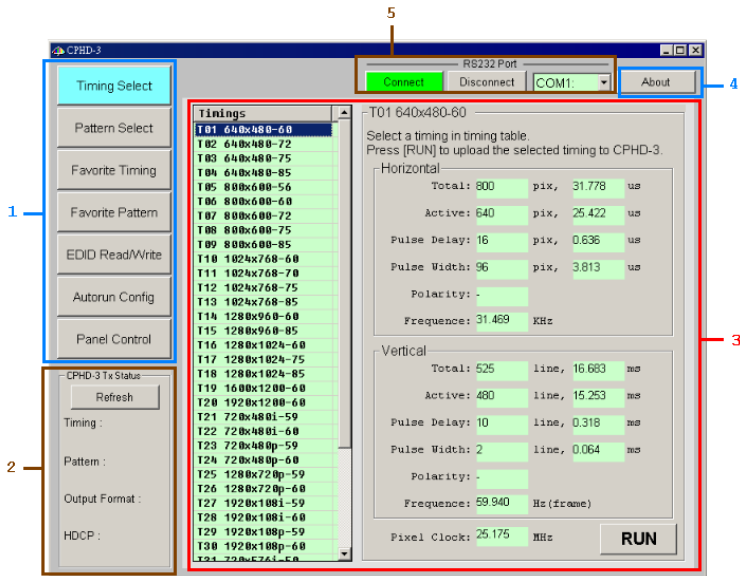

1. Main Function Selection:
 - Timing Select:** Select a timing among T01~T39
 - Pattern Select:** Select a pattern among P01~P51
 - Favorite Timing:** Select favorite timings among T01~T39
 - Favorite Pattern:** Select favorite patterns among P01~P51
 - EDID Read/Write:** Read, write EDID contents and analyze EDID data
 - Auto-run Config:** Configure auto-run list
 - Panel Control:** Control system functions
2. **Status Monitor**
 - Click [Refresh] button to get system status
3. **Work Area**
 - Different main functions have their own working area
4. **About**
 - Get PC software and system firmware version number
5. **RS-232 Setup**
 - Select RS-232 Com Port and turn the connection On/Off

6.8 Firmware Revision History

VERSION	RELEASE DATE	DESCRIPTION
v1.0	19/06/09	First release
v1.1	05/07/09	Add pattern 51-RGB Delay.
v1.2	22/01/10	Modify pattern 19 & 21
v1.3	26/02/10	Modify "System Setup"

6.9 Timings Table

No.	Resolution	V Hz	No.	Resolution	V Hz
T01	640×480	60	T21	720×480i	59
T02	640×480	72	T22	720×480i	60
T03	640×480	75	T23	720×480p	59
T04	640×480	85	T24	720×480p	60
T05	800×600	56	T25	1280×720p	59
T06	800×600	60	T26	1280×720p	60
T07	800×600	72	T27	1920×1080i	59
T08	800×600	75	T28	1920×1080i	60
T09	800×600	85	T29	1920×1080p	59
T10	1024×768	60	T30	1920×1080p	60
T11	1024×768	70	T31	720×576i	50
T12	1024×768	75	T32	720×576p	50
T13	1024×768	85	T33	1280×720p	50
T14	1280×960	60	T34	1920×1080i	50
T15	1280×960	85	T35	1920×1080p	50
T16	1280×1024	60	T36	1920×1080p	23
T17	1280×1024	75	T37	1920×1080p	24
T18	1280×1024	85	T38	1366×768	60
T19	1600×1200	60	T39	1366×768	50
T20	1920×1200	60			









6.10 Patterns Table

- Graphic Test Patterns: 45 Patterns
- Data Analysis Patterns: 6 Patterns (Include P32, P38, P39, P48, P49, P50)





P01 WHITE		P24 MULTI-BURST	
P02 BLUE		P25 Pluge	*
P03 RED		P26 GRID-1	
P04 MAGENTA		P27 GRID-36	
P05 GREEN		P28 GRAY-256-R	
P06 CYAN		P29 GRAY-256-G	
P07 YELLOW		P30 GRAY-256-B	
P08 BLACK		P31 CIRCLES	
P09 RED Setting	*	P32 EDID	*
P10 GRN Setting	*	P33 H Grey Scale	
P11 BLUE Setting	*	P34 Hori.RGB Bar	
P12 GRAY Setting	*	P35 SMPT Bar	
P13 COLOR BAR		P36 Split Bar	
P14 GRAY-8		P37 CROSS HATCH	*
P15 GRAY-16		P38 AUDIO	
P16 GRAY-32		P39 HDCP	*
P17 GRAY-64		P40 Win Blue	
P18 GRAY-256		P41 Win Red	
P19 V line ONOFF		P42 Win Magenta	
P20 BW-12		P43 Win Green	
P21 H line ONOFF		P44 Win Cyan	
P22 HOR.-3		P45 Win Yellow	
P23 HOR.-6		P46 Motion	*
		P47 Color Setting	
		P48 Rx Timing	*
		P49 Rx Video	*
		P50 Rx Audio	*
		P51 RGB Delay	
		System Setup	

*Supports [OPTION] setting.

6.11 Patterns Description







GROUP	NO.	PATTERN	DESCRIPTION
Full Screen Purity	P01		Purity pattern Purity offers eight different full field patterns: Black, White (100% Y)
	P02		Primary colors: Red, Green, Blue
	P03		Complementary colors: Magenta, Yellow, Cyan
	P04		P01: White
	P05		P02: Blue
	P06		P03: Red
	P07		P04: Magenta
	P08		P05: Green
			P06: Cyan
			P07: Yellow
			P08: Black
APPLICATION			

GROUP	NO.	PATTERN	DESCRIPTION
<ol style="list-style-type: none"> 1. The red and green patterns are most frequently used for checking color purity. When the red pattern is selected only this color should be visible; the presence of any other color is an indication that color purity needs adjustment. 2. The green pattern provides a purity check for three in-line tubes. In the in-line tubes, the guns are in a horizontal position and the green gun is located in the center. 3. The blue pattern is the complementary color and often used to check color performance. 4. Red is used to ensure there is no interference between the sound and chroma carrier. Furthermore the red pattern is used to adjust the long play delay level to a minimum flicker. 5. In addition to the primary and complementary colors a 100% white pattern can be selected as well as a black pattern with color burst to check. 			
Color Setting	P09	Red Setting	Press [OPTION],[PATTERN ▲/▼] to adjust color level.
	P10	Green Setting	There are 11 steps to adjust color level: 0, 25, 51, 76, 102, 127(default), 153, 178, 204, 229 and 255.
P11	Blue Setting		
P12	Gray Setting		
	P47	Color Setting	The RS-232 PC software can be used to adjust each of the color component values.
APPLICATION			
This can show the overall color performance, amplitude response/ resolution and linearity of chroma amplitude.			

GROUP	NO.	PATTERN	DESCRIPTION
Color Bar	P13		8 Bars
	P34		Hori. RGB Bar
	P35		SMPTE Color Bar
	P36		Split Color Bar
	P51		RGB Delay







APPLICATION

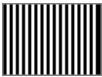

The Color matrix test is to test for a fixed quantity of color. Generates R, G, B color bars.







Gray Scale	P14		8 steps
	P15		16 steps
	P16		32 steps
	P17		64 steps
	P18		256 steps
	P33		H Grey Scale

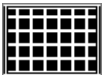





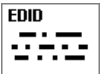

APPLICATION



This is used to locate faulty linearity of the video amplifier or greyscale setting. Nonlinearities mainly result in a compression of the white level.

GROUP	NO.	PATTERN	DESCRIPTION
Black White Line	P19		V Line ONOFF (black 1 pixel, white 1 pixel)
	P20		Vertical BW12 (black 12 pixels, white 12 pixels)
	P21		H Line ONOFF (black 1 pixel, white 1 pixel)
	P22		Horizontal BW3 (black 3 pixels, white 3 pixels)
	P23		Horizontal BW6 (black 6 pixels, white 6 pixels)
	P24		Multi-Burst BW6+BW3+BW2+BW1
APPLICATION			
<p>The vertical patterns serve for a quick check of a color monitor's horizontal bandwidth and phase behavior during a video transmission. It also verifies video amplifier and color temperature.</p> <p>The horizontal patterns serve for a quick check of a color monitors vertical bandwidth and phase behavior during a video transmission. It also verifies video amplifier and color temperature.</p>			
PLUGE	P25		Picture Line-Up Generation Equipment Press [OPTION] to select color range Full Range=0~255 Limited Range=16~235, PC/HD output gets Full Range=0%~100%

GROUP	NO.	PATTERN	DESCRIPTION
APPLICATION			
<p>PLUGE is used to perform accurate and consistent line-up of picture monitors. The usual procedure is to adjust the brightness control of a monitor so that bar 1 is invisible on the background while bar 2 can be still distinguished. The white level luminance is mainly adjusted by the contrast control to 70 ± 10 cd/m² by means of the upper 100% white area of the vertical grayscale.</p>			
Grid	P26		1x1 (pixel) checkerboard
	P27		36x36 (pixels) checkerboard
	P37		Cross Hatch Press [OPTION] to inverse black/white.
APPLICATION			
<p>This pattern is mainly used for checking and aligning dynamic and corner convergence of TVs or monitors.</p>			

GROUP	NO.	PATTERN	DESCRIPTION
Gradient	P28		Red Gradient
	P29		Green Gradient
	P30		Blue Gradient
APPLICATION			
This is used to locate faulty linearity of the video amplifier. Nonlinearities mainly result in a compression of the color level.			
Circle	P31		Circles
APPLICATION			
Can be used for checking the overall linearity and geometry of the screen of a monitor or TV.			
EDID	P32		EDID Analysis Press[OPTION],[PATTERN▲/▼] to analyze sink's EDID contents.
Audio	P38		Audio Control Source, Channel Number, Sampling Rate, I2S Controls

GROUP	NO.	PATTERN	DESCRIPTION
HDCP	P39		HDCP handshaking and link-integrity test If sink is a repeater, press [OPTION] to show BKS'V List / V' value.
Window Purity	P40		75% of Height/Width Window Pattern.
	P41		
	P42		
	P43		
	P44		
	P45		
APPLICATION			
Electromagnetism can cause distortions to appear because a CRT monitor is controlled by electro magnetism. If there are no distortions then the monitor has 75% color purity.			
Motion	P46		Font base motion test. Press [OPTION] to select motion object. The RS-232 PC software can be used to edit the custom string.

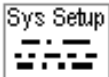
GROUP	NO.	PATTERN	DESCRIPTION
APPLICATION			
Check that digital video is being processed correctly, especially the AD conversion of modern TV equipment. This pattern can be used to check moving pictures or slow motion applications on VCR's or other personal video devices.			
Rx Data Analysis	P48		<p>HDMI/DVI input timing detection and analysis.</p> <p>Press [OPTION] to pull hot-plug</p> <p>NOTE: The values below are approximate.</p> <p>Pixel Rate, Horizontal Frequency, and Vertical Frequency (These are for reference only).</p>
	P49		<p>HDMI/DVI input video packets and inframes detection and analysis.</p> <p>Press [OPTION] to pull hot-plug</p>
	P50		<p>HDMI input audio packets and inframes detection and analysis.</p> <p>Press [OPTION] to pull hot-plug</p>
Sys Setup			<p>System Setup</p> <p>Built-in Rx EDID setup, IR remote address setup.</p>

7. CONNECTION DIAGRAM

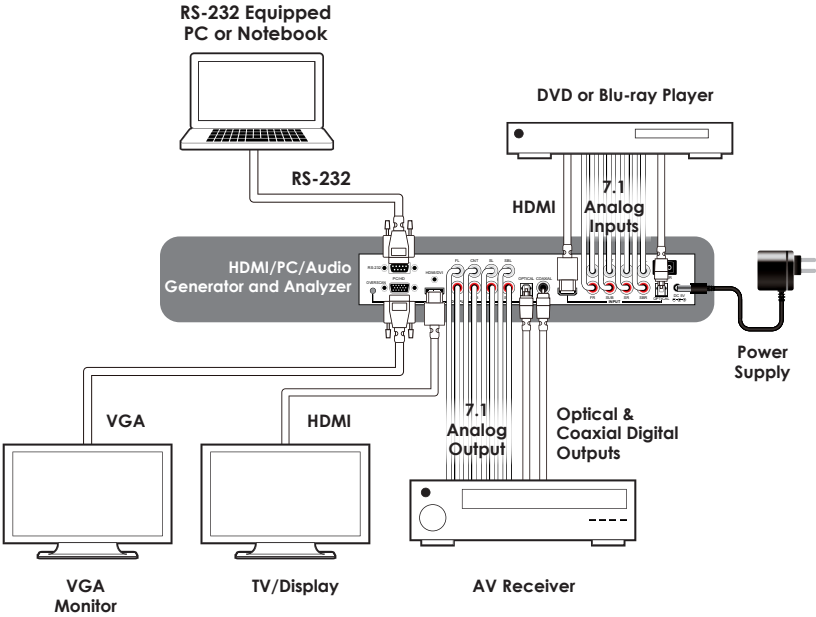

8. SPECIFICATIONS

39 Timings: 640×480~1920×1200 (Details in section '6.9 TIMINGS TABLE')

SD timings: 480i, 480p, 576i and 576p

HD timings: 720p up to 1080p

PC timings: VGA up to UXGA, WUXGA (Reduced Blanking Pixel Rate at 154 MHz)

Note: Analog PC output only supports PC timings

Analog HD output only supports SD/HD timings

HDMI/DVI output supports all timings

Note: This system doesn't support user edited timing

51 Patterns:

Graphic Test Patterns: 45 Patterns (Details in section '6.10 PATTERNS TABLE')

Data Analysis Patterns: 6 Patterns

Note: This system doesn't support pattern editing by the user

HDMI/DVI Input and Output:

Signal: TMDS single link and clock bandwidth up to 225 MHz

Connector: HDMI TYPE-A. DVI input or output needs DVI to HDMI adaptor

Analog PC/HD Output:

Signal: Analog R/G/B/H/V or analog YPbPr supports color space conversion.

Component HD outputs support tri-level sync and color space conversion.

For HD component output, DB15 to 3-RCA adaptor cable is required.

RGB	Video	0.7 Vp-p	75Ω
	Sync.	5Vp-p	
YPbPr	Video	0.7Vp-p	75Ω
	Sync.	0.3Vp-p	75Ω

Video Color Space and Deep Color:

HDMI Output: RGB444 (8/10/12-bit), YCbCr444 (8/10/12-bit) and YCbCr422 (8-bit)

DVI Output: RGB444 (8-bit)

PC Output: RGB with separate sync H/V or YPbPr with separate sync H/V and without composite sync on Y.

HD Output: YPbPr with composite sync on Y or RGB with composite sync on G.

Audio Inputs:

External Analog 7.1CH: RCA jacks.

External Optical: TOSLINK jack.

Internal Sinewave:

Supports LPCM 2CH, 5.1CH and 7.1CH.

Supports sampling rates 48KHz, 96KHz and 192KHz (Refer to Audio Output)

Sinewave Frequency: FL (Front Left)=1000Hz, FR (Front Right)=600Hz, CNT (Center)=800Hz, SUB (Subwoofer)=400Hz, SL (Surround Left)=1200Hz, SR (Surround Right)=1400Hz, SBL (Surround Back Left)=1600Hz, SBR (Surround Back Right)=1800Hz

Note: This system doesn't support bitstream (Dolby, DTS) decoding from an external optical source.

Audio Outputs:

Analog 7.1CH: RCA jacks.

Optical: Toslink jack.

Coaxial: RCA jack.

HDMI: Support I²S bus control.

Pattern 38: For Audio control functions please refer to the below table.
(SR¹=Sampling Rate)

2CH: FL (Front Left) and FR (Front Right). **6CH:** FL (Front Left), FR (Front Right), CNT (Center), SUB (Subwoofer), SL (Surround Left) and SR (Surround Right)

OUTPUT INPUT	Analog 7.1CH	OPTICAL/ COAX	HDMI
Ext. 7.1CH	Bypass	LPCM 2CH SR ¹ : 48 kHz	LPCM 2CH, 6CH SR ¹ :48 kHz
Ext. OPTICAL	2CH	Bypass	Bypass
Int. Sinewave	2CH, 6CH, 8CH	LPCM 2CH SR ¹ :48 kHz	LPCM 2CH, 6CH, 8CH SR ¹ :48 kHz, 96 kHz, 192 kHz Condition: <ol style="list-style-type: none"> 1. Sampling Rate 48 kHz supports 2CH / 6CH / 8CH for all timings. 2. Sampling Rate 96 kHz supports 2CH for 480i/p, 576i/p and VGA60, and supports 2CH / 6CH / 8CH for all other timings. 3. Sampling Rate 192 kHz supports only 2CH for all timings.

Audio Specification:

OUTPUT		INPUT	External Analog 7.1CH 2Vrms 1KHZ	External OPTICAL 0dBFS	Internal SINEWAVE 8CH
Analog 7.1CH	RMS LEVEL		575±20mVrms	1±0.05Vrms	780±20mVrms
	THD+N		0.01%↓	0.01%↓	0.01%↓
	Freq Response		-11±1dBrA	0~-1dBrA	
	SNR		80dB↑	80dB↑	
	Crosstalk		-60dB↑	-80dB↓	
OPT/ COAX	RMS LEVEL		-6dBFS±1	0dB	-4±0.1dBFS
	THD+N		0.01%↓	0.01%↓	0.01%↓
	Freq Response		-6±1dBrA	0dBFS	
	SNR		80dB↑	80dB↑	
	Crosstalk		-60dB↑	-80dB↓	
HDMI	RMS LEVEL		0dBFS~-1dBFS	0dB	-4±0.1dBFS
	THD+N		0.01%↓	0.01%↓	0.01%↓
	Freq Response		-1±1dBrA	0dBFS	
	SNR		80dB↑	80dB↑	
	Crosstalk		-60dB↑	-80dB↓	

Pattern 32 - EDID Analysis:

The EDID analysis pattern has three different options and a Block 0/1 analysis. The system will copy the Sink EDID and use the built-in Rx EDID to analyze and display information.

Below are the ways to get the EDID:

1. Built-in Rx EDID
2. From HDMI/DVI Display Sink EDID
3. From VGA Display EDID

The supported EDID analysis versions are: VESA E-EDID v1.3 and EIA/CEA 861D version 3 standard.

Pattern P39 - HDCP Analysis:

This system supports both HDCP handshaking and link-integrity testing, and also Sink Repeater BKSv list and V' values.

HDMI/DVI Input Analysis:

Supports manual Hot-plug (Press [OPTION])

Pattern 48: HDMI/DVI Video Timing Detection and Analysis

Pattern 49: HDMI/DVI Video Packets and Inframe Detection and Analysis.

Pattern 50: HDMI Audio Packets and Inframe Detection and Analysis.

User Interface:

LCM, LED indicators, IR remote,

RS-232 remote: D-SUB9 male connector.

PC software supports RS-232 remote control.

Power Supply	5V DC / 3.2A (US/EU standards, CE/FCC/ UL certified)
Dimensions	280 mm (W)×145 mm (D)×44 mm (H)
Weight	1400g
Chassis Material	Aluminum
Silkscreen Color	Black with Red
Operating Temperature	0 °C~40 °C/32 °F~104 °F
Storage Temperature	-20°C~60 °C/-4 °F~140 °F
Relative Humidity	20%~90% RH (non-condensing)
Power Consumption	13W

9. ACRONYMS

ACRONYM	COMPLETE TERM
CEA	Consumer Electronic Association
BKSV	B Key Selection Vector
DVI	Digital Visual Interface
EDID	Extended Display Identification Data
EIA	Electronic Industries Alliance
HDCP	High-bandwidth Digital Content Protection
HDMI	High-Definition Multimedia Interface
LCD	Liquid Crystal Display
LPCM	Linear Pulse Code Modulation
TMDS	Transition Minimized Differential Signaling
UXGA	Ultra Extended Graphics Array
VESA	Video Electronics Standards Association
WUXGA	Widescreen Ultra Extended Graphics Array

