



CPRO-2E

1×2 HDMI Splitter



Operation Manual

DISCLAIMERS

The information in this manual has been carefully checked and is believed to be accurate. Cypress Technology assumes no responsibility for any infringements of patents or other rights of third parties which may result from its use.

Cypress Technology assumes no responsibility for any inaccuracies that may be contained in this document. Cypress also makes no commitment to update or to keep current the information contained in this document.

Cypress Technology reserves the right to make improvements to this document and/or product at any time and without notice.

COPYRIGHT NOTICE

No part of this document may be reproduced, transmitted, transcribed, stored in a retrieval system, or any of its part translated into any language or computer file, in any form or by any means—electronic, mechanical, magnetic, optical, chemical, manual, or otherwise—without express written permission and consent from Cypress Technology.

© Copyright 2011 by Cypress Technology.

All Rights Reserved.

Version 1.1 August 2011

TRADEMARK ACKNOWLEDGMENTS

All products or service names mentioned in this document may be trademarks of the companies with which they are associated.





SAFETY PRECAUTIONS

Please read all instructions before attempting to unpack, install or operate this equipment and before connecting the power supply.

Please keep the following in mind as you unpack and install this equipment:

- Always follow basic safety precautions to reduce the risk of fire, electrical shock and injury to persons.
- To prevent fire or shock hazard, do not expose the unit to rain, moisture or install this product near water.
- Never spill liquid of any kind on or into this product.
- Never push an object of any kind into this product through any openings or empty slots in the unit, as you may damage parts inside the unit.
- Do not attach the power supply cabling to building surfaces.
- Use only the supplied power supply unit (PSU). Do not use the PSU if it is damaged.
- Do not allow anything to rest on the power cabling or allow any weight to be placed upon it or any person to walk on it.
- To protect the unit from overheating, do not block any vents or openings in the unit housing that provide ventilation and allow for sufficient space for air to circulate around the unit.

REVISION HISTORY

VERSION NO.	DATE DD/MM/YY	SUMMARY OF CHANGE
VS1	16/10/12	First Release
VR2	07/03/13	STD EDID Spec.
VS3	02/08/13	Updated text/diagrams



CONTENTS

1. Introduction	1
2. Applications	1
3. Package Contents	1
4. System Requirements	1
5. Features	2
6. Operation Controls and Functions	3
6.1 Front Panel.....	3
6.2 Rear Panel	3
7. Connection Diagram	4
8. Specifications	5
9. Acronyms	6



1. INTRODUCTION

This high performance 1 by 2 HDMI splitter distributes one HDMI input to two simultaneous HDMI outputs and supports 4K×2K, 3D, 12-bit Deep Color as well as High Definition Lossless Audio. With its 3Gbps bandwidth it supports the latest HDMI standards so you can be sure of superior HDMI distribution.

2. APPLICATIONS

- Simultaneously display one HDMI source on 2 displays
- Showroom display
- University lecture hall display
- Retail sales display
- Commercial presentation splitter

3. PACKAGE CONTENTS

- 1×1 by 2 HDMI Splitter
- 1×5V/2.6A DC Power Supply Adaptor
- Operation Manual

4. SYSTEM REQUIREMENTS

- HDMI equipped source device such as a DVD/Blu-ray player with HDMI or DVI to HDMI cable
- HDMI equipped displays (HDTVs or projectors) or AV Receivers with HDMI cables

5. FEATURES

- HDMI and DVI compatible
- Fully HDCP compliant
- Supports 3D
- Supports HDTV resolutions up to 4K×2K@30 Hz
- Supports PC Resolutions of VGA to WUXGA
- Supports 1080p@60 Hz, Deep Color 12-bit
- Supports LPCM 7.1CH, Dolby TrueHD, and DTS-HD Master Audio
- Supports HDMI cable distances of up to 10m input and 10m output (8/12-bit)

Note: When displaying a 3D signal with a higher bandwidth than 225 MHz or a 4K×2K resolution source, a High Speed HDMI cable is required.

6. OPERATION CONTROLS AND FUNCTIONS

6.1 Front Panel

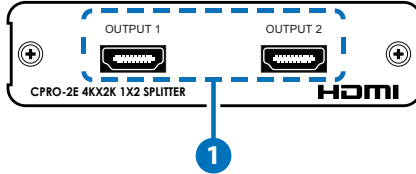

- 1 HDMI OUTPUTS 1/2:** Connect each of the output ports to an HDMI display for simultaneous HDMI distribution.

6.2 Rear Panel

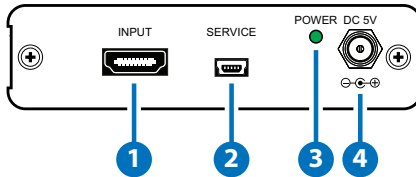

- 1 HDMI INPUT:** Connect the input port to the HDMI or DVI output of your source equipment such as DVD player or set-top box.
- 2 SERVICE:** Manufacturer use only.
- 3 POWER LED:** The power LED will illuminate when the unit is powered.
- 4 DC 5V:** Connect the 5V DC power supply into the splitter and plug the adaptor to AC wall outlet.

7. CONNECTION DIAGRAM

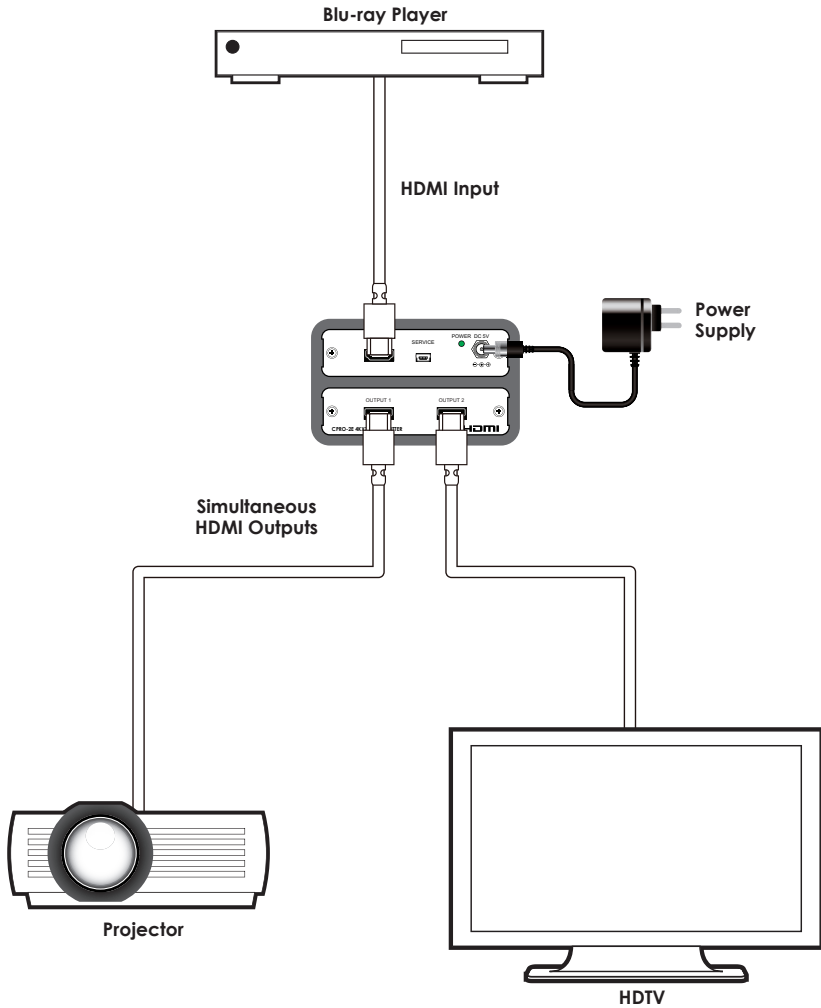



8. SPECIFICATIONS

Video Bandwidth	340 MHz/10.2 Gbps
Input Port	1×HDMI (Female connector), 1×USB (Manufacturer use only)
Output Ports	2×HDMI (Female connector)
Output Resolutions	480i~1080p@50/60, 1080p@24/50/60, VGA~UXGA, Ultra HD (4K×2K@30)
Power Supply	5 V/2.6 A DC (US/EU standards, CE/FCC/UL certified)
ESD Protection	Human body model: ±8kV (air-gap discharge) ±4kV (contact discharge)
Dimensions	103 mm (W)×155 mm (D)×25 mm (H)
Weight	298 g
Chassis Material	Metal
Color	Black
Operating Temperature	0 °C~40 °C/32 °F~104 °F
Storage Temperature	-20 °C~60 °C/-4 °F~140 °F
Relative Humidity	20~90% RH (non-condensing)
Power Consumption	2.85 W

9. ACRONYMS

ACRONYM	COMPLETE TERM
4K×2K	Ultra HD Resolution (3840×2160)
HDMI	High-Definition Multimedia Interface
HDTV	High-Definition Television



CYPRESS TECHNOLOGY CO., LTD

Home page: <http://www.cypress.com.tw>



CPRO-4E

1×4 HDMI Splitter



Operation Manual

DISCLAIMERS

The information in this manual has been carefully checked and is believed to be accurate. Cypress Technology assumes no responsibility for any infringements of patents or other rights of third parties which may result from its use.

Cypress Technology assumes no responsibility for any inaccuracies that may be contained in this document. Cypress also makes no commitment to update or to keep current the information contained in this document.

Cypress Technology reserves the right to make improvements to this document and/or product at any time and without notice.

COPYRIGHT NOTICE

No part of this document may be reproduced, transmitted, transcribed, stored in a retrieval system, or any of its part translated into any language or computer file, in any form or by any means—electronic, mechanical, magnetic, optical, chemical, manual, or otherwise—without express written permission and consent from Cypress Technology.

© Copyright 2011 by Cypress Technology.

All Rights Reserved.

Version 1.1 August 2011

TRADEMARK ACKNOWLEDGMENTS

All products or service names mentioned in this document may be trademarks of the companies with which they are associated.





SAFETY PRECAUTIONS

Please read all instructions before attempting to unpack, install or operate this equipment and before connecting the power supply.

Please keep the following in mind as you unpack and install this equipment:

- Always follow basic safety precautions to reduce the risk of fire, electrical shock and injury to persons.
- To prevent fire or shock hazard, do not expose the unit to rain, moisture or install this product near water.
- Never spill liquid of any kind on or into this product.
- Never push an object of any kind into this product through any openings or empty slots in the unit, as you may damage parts inside the unit.
- Do not attach the power supply cabling to building surfaces.
- Use only the supplied power supply unit (PSU). Do not use the PSU if it is damaged.
- Do not allow anything to rest on the power cabling or allow any weight to be placed upon it or any person to walk on it.
- To protect the unit from overheating, do not block any vents or openings in the unit housing that provide ventilation and allow for sufficient space for air to circulate around the unit.

REVISION HISTORY

VERSION NO.	DATE DD/MM/YY	SUMMARY OF CHANGE
VS1	16/10/12	First Release
VR2	07/03/13	STD EDID Spec.
VR2	02/08/13	Updated text/diagrams



CONTENTS

1. Introduction	1
2. Applications	1
3. Package Contents	1
4. System Requirements	1
5. Features	2
6. Operation Controls and Functions	3
6.1 Front Panel.....	3
6.2 Rear Panel	3
7. Connection Diagram	4
8. Specifications	5
9. Acronyms	5





1. INTRODUCTION

This high performance 1 by 4 HDMI splitter distributes one HDMI input to up to four simultaneous HDMI outputs and supports 4K×2K, 3D, 12-bit Deep Color as well as High Definition Lossless Audio. With its 3Gbps bandwidth it supports the latest HDMI standards so you can be sure of superior HDMI distribution.

2. APPLICATIONS

- Simultaneously display one HDMI source on 4 displays
- Showroom display
- University lecture hall display
- Retail sales display
- Commercial presentation splitter

3. PACKAGE CONTENTS

- 1×1 by 4 HDMI Splitter
- 1×5V/2.6A DC Power Supply Adaptor
- Operation Manual

4. SYSTEM REQUIREMENTS

- HDMI equipped source device such as a DVD/Blu-ray player with HDMI or DVI to HDMI cable
- HDMI equipped displays (HDTVs or projectors) or AV Receivers with HDMI cables

5. FEATURES

- HDMI and DVI compatible
- Fully HDCP compliant
- Supports 3D
- Supports HDTV resolutions up to 4K×2K@30 Hz
- Supports PC Resolutions of VGA to WUXGA
- Supports 1080p@60 Hz, Deep Color 12-bit
- Supports LPCM 7.1CH, Dolby TrueHD, and DTS-HD Master Audio
- Supports HDMI cable distances of up to 10m input and 10m output (8/12-bit)

Note: When displaying a 3D signal with a higher bandwidth than 225 MHz or a 4K×2K resolution source, a High Speed HDMI cable is required.

6. OPERATION CONTROLS AND FUNCTIONS

6.1 Front Panel

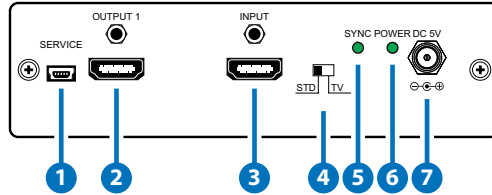

- 1 SERVICE:** Manufacturer use only.
- 2 HDMI OUTPUT 1:** Connect each of the output ports to the HDMI display for simultaneous HDMI distribution.
- 3 HDMI INPUT:** Connect the input port to the HDMI or DVI output of your source equipment such as DVD player or set-top box with an HDMI cable.
- 4 EDID STD/TV:** The default factory setting is TV, when in this mode, the unit will detect the first HDMI output device's EDID settings and record them in the unit's memory. If there are any audio or video issues then switch the unit to STD (Standard) mode and power cycle it, the unit will be configured as standard stereo (PCM) Audio and initiate a search for a common compatible video resolution.
- 5 SYNC LED:** The LED will illuminate when the HDMI source signal is connected to the input port.
- 6 POWER LED:** The LED will illuminate when the unit is powered.
- 7 DC 5V:** Connect the 5V DC power supply into the splitter and Plug the adaptor to AC wall outlet.

6.2 Rear Panel

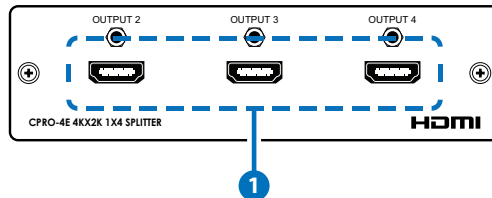

- 1 HDMI OUTPUTS 2/3/4:** Connect each of the output ports to an HDMI display for simultaneous HDMI distribution.

7. CONNECTION DIAGRAM

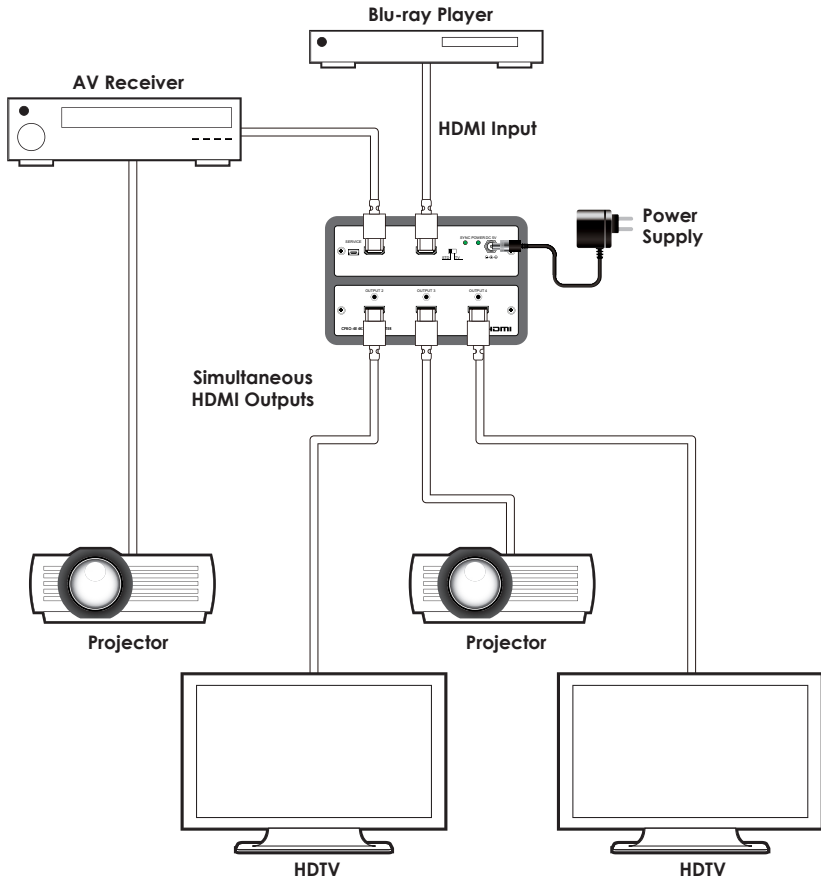



8. SPECIFICATIONS

Video Bandwidth	300 MHz/9 Gbps
Input Port	1×HDMI (Female connector), 1×USB (Manufacturer use only)
Output Ports	4×HDMI (Female connector)
Output Resolutions	480i~1080p@50/60, 1080p@24/50/60, VGA~UXGA, Ultra HD (4K×2K@30)
ESD Protection	Human body model: ±8kV (air-gap discharge) ±4kV (contact discharge)
Dimensions	142 mm (W)×105 mm (D)×38 mm (H)
Weight	378g
Chassis Material	Metal
Color	Black
Operating Temperature	0 °C~40 °C/32 °F~104 °F
Storage Temperature	-20 °C~60 °C/-4 °F~140 °F
Relative Humidity	20~90% RH (non-condensing)
Power Consumption	3.3 W

9. ACRONYMS

ACRONYM	COMPLETE TERM
4K×2K	Ultra HD Resolution (3840×2160)
HDMI	High-Definition Multimedia Interface
HDTV	High-Definition Television



CYPRESS TECHNOLOGY CO., LTD

Home page: <http://www.cypress.com.tw>



CPRO-8E

1×8 HDMI Splitter



Operation Manual

DISCLAIMERS

The information in this manual has been carefully checked and is believed to be accurate. Cypress Technology assumes no responsibility for any infringements of patents or other rights of third parties which may result from its use.

Cypress Technology assumes no responsibility for any inaccuracies that may be contained in this document. Cypress also makes no commitment to update or to keep current the information contained in this document.

Cypress Technology reserves the right to make improvements to this document and/or product at any time and without notice.

COPYRIGHT NOTICE

No part of this document may be reproduced, transmitted, transcribed, stored in a retrieval system, or any of its part translated into any language or computer file, in any form or by any means—electronic, mechanical, magnetic, optical, chemical, manual, or otherwise—without express written permission and consent from Cypress Technology.

© Copyright 2011 by Cypress Technology.

All Rights Reserved.

Version 1.1 August 2011

TRADEMARK ACKNOWLEDGMENTS

All products or service names mentioned in this document may be trademarks of the companies with which they are associated.





SAFETY PRECAUTIONS

Please read all instructions before attempting to unpack, install or operate this equipment and before connecting the power supply.

Please keep the following in mind as you unpack and install this equipment:

- Always follow basic safety precautions to reduce the risk of fire, electrical shock and injury to persons.
- To prevent fire or shock hazard, do not expose the unit to rain, moisture or install this product near water.
- Never spill liquid of any kind on or into this product.
- Never push an object of any kind into this product through any openings or empty slots in the unit, as you may damage parts inside the unit.
- Do not attach the power supply cabling to building surfaces.
- Use only the supplied power supply unit (PSU). Do not use the PSU if it is damaged.
- Do not allow anything to rest on the power cabling or allow any weight to be placed upon it or any person to walk on it.
- To protect the unit from overheating, do not block any vents or openings in the unit housing that provide ventilation and allow for sufficient space for air to circulate around the unit.

REVISION HISTORY

VERSION NO.	DATE DD/MM/YY	SUMMARY OF CHANGE
VS1	16/10/12	First Release
VR2	07/03/13	STD EDID Spec.
VR2	02/08/13	Updated text/diagrams



CONTENTS

1. Introduction	1
2. Applications	1
3. Package Contents	1
4. System Requirements	1
5. Features	2
6. Operation Controls and Functions	3
6.1 Front Panel.....	3
6.2 Rear Panel	3
7. Connection Diagram	4
8. Specifications	5
9. Acronyms	5





1. INTRODUCTION

This high performance 1 by 8 HDMI splitter distributes one HDMI input to up to eight simultaneous HDMI outputs and supports 4K×2K, 3D, 12-bit Deep Color as well as High Definition Lossless Audio. With its 3Gbps bandwidth it supports the latest HDMI standards so you can be sure of superior HDMI distribution.

2. APPLICATIONS

- Simultaneously display one HDMI source on 8 displays
- Showroom display
- University lecture hall display
- Retail sales display

3. PACKAGE CONTENTS

- 1×1 by 8 HDMI Splitter
- 1×5V/3A DC Power Supply Adaptor
- Operation Manual

4. SYSTEM REQUIREMENTS

- HDMI equipped source device such as a DVD/Blu-ray player with HDMI or DVI to HDMI cable
- HDMI equipped displays (HDTVs or projectors) or AV Receivers with HDMI cables

5. FEATURES

- HDMI and DVI compatible
- Fully HDCP compliant
- Supports 3D
- Supports HDTV resolutions up to 4K×2K@30 Hz
- Supports PC Resolutions of VGA to WUXGA
- Supports 1080p@60 Hz, Deep Color 12-bit
- Supports LPCM 7.1CH, Dolby TrueHD, and DTS-HD Master Audio
- Supports HDMI cable distances of up to 10m input and 10m output (8/12-bit)

Note: When displaying a 3D signal with a higher bandwidth than 225 MHz or a 4K×2K resolution source, a High Speed HDMI cable is required.

6. OPERATION CONTROLS AND FUNCTIONS

6.1 Front Panel

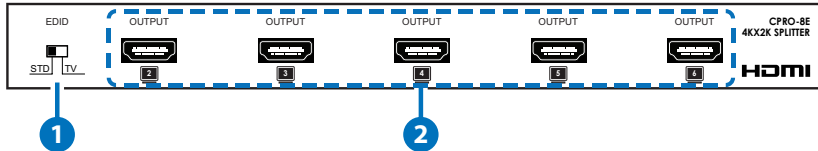

- 1 EDID STD/TV:** The default factory setting is TV, when in this mode, the unit will detect the first HDMI output device's EDID settings and record them in the unit's memory. If there are any audio or video issues then switch the unit to STD (Standard) mode and power cycle it, the unit will be configured as standard stereo (PCM) Audio and initiate a search for a common compatible video resolution.
- 2 HDMI OUTPUTS 2/3/4/5/6:** Connect each of the output ports to an HDMI display for simultaneous HDMI distribution.

6.2 Rear Panel

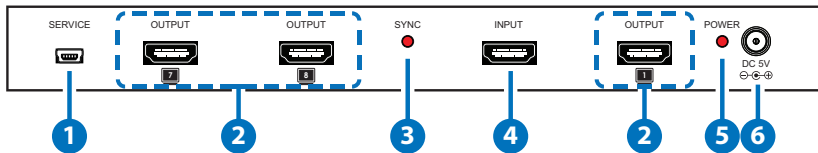

- 1 SERVICE:** Manufacturer use only.
- 2 HDMI OUTPUTS 7/8/1:** Connect each of the output ports to an HDMI display for simultaneous HDMI distribution.
- 3 SYNC LED:** The LED will illuminate when the HDMI source signal is connected to the input port.
- 4 HDMI INPUT:** Connect the input port to the HDMI or DVI output of your source equipment such as DVD player or set-top box.
- 5 POWER LED:** The power LED will illuminate when the unit is powered.
- 6 DC 5V:** Connect the 5V DC power supply into the splitter and Plug the adaptor to AC wall outlet.

7. CONNECTION DIAGRAM

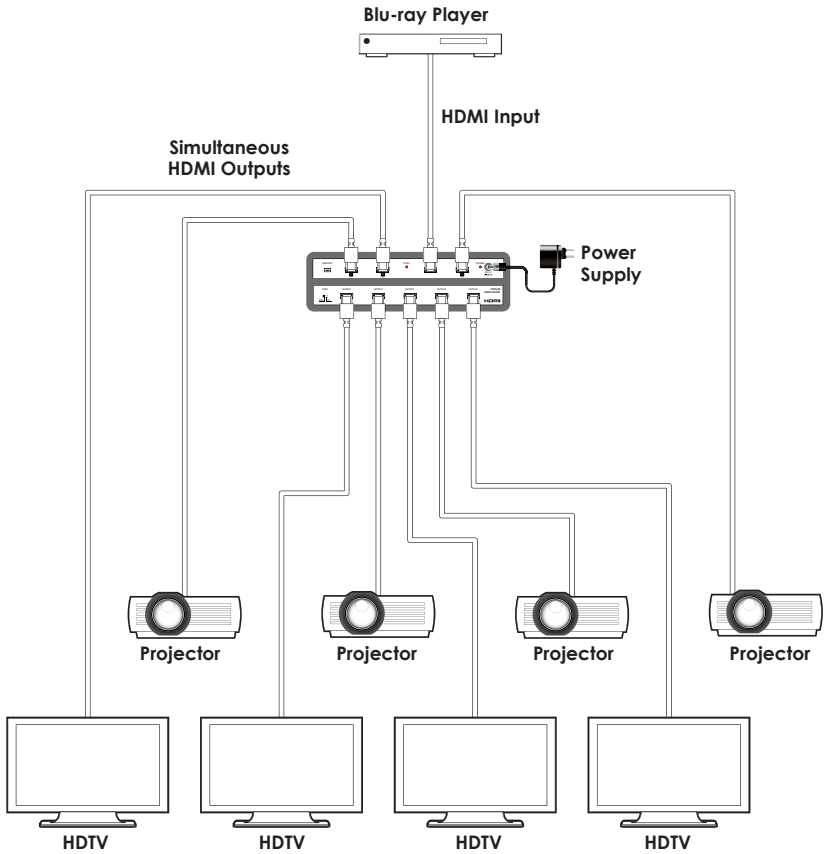



8. SPECIFICATIONS

Video Bandwidth	300 MHz/9 Gbps
Input Port	1×HDMI (Female connector), 1×USB (Manufacturer use only)
Output Ports	8×HDMI (Female connector)
Output Resolutions	480i~1080p@50/60, 1080p@24/50/60, VGA~UXGA, Ultra HD (4K×2K@30)
ESD Protection	Human body model: ±8kV (air-gap discharge) ±4kV (contact discharge)
Dimensions	240 mm (W)×110 mm (D)×30 mm (H)
Weight	710 g
Chassis Material	Metal
Color	Black
Operating Temperature	0 °C~40 °C/32 °F~104 °F
Storage Temperature	-20 °C~60 °C/-4 °F~140 °F
Relative Humidity	20~90% RH (non-condensing)
Power Consumption	9.8 W

9. ACRONYMS

ACRONYM	COMPLETE TERM
4K×2K	Ultra HD Resolution (3840×2160)
HDMI	High-Definition Multimedia Interface
HDTV	High-Definition Television



CYPRESS TECHNOLOGY CO., LTD

Home page: <http://www.cypress.com.tw>