

VGA and Audio CAT-5 AV Extender

AVE-301T
AVE-301R
AVE-304T
AVE-308T
AVE-316T

User Manual

◀ V1.2 ▶



DataBay

www.DataBay.com.tw

www.green-box.com.tw

Contents

1. Product Introduction.....	4
2. Product Features.....	5
3. System Devices & Function	5
4. Panel Descriptions	6
5. Installation and Operation.	9
5.1 AVE-301T Single-Port Transmitter Installation:	9
5.2 Receiver AVE-301R installation and UTP Connection	10
5.3 AVE-300 Multi-Port Model: Installation and Operation.....	11
6. Specifications.....	13
7. Order Information.....	14
8. Remarks.....	15
9. Notice	15

Certifications

FCC

This equipment has been tested and found to comply with Part 15 of the FCC Rules.

Operation is subject to the following two conditions:

- (1) This device may not cause harmful interference
- (2) This device must accept any interference received, including interference that may cause undesired operation.

CE

This equipment is in compliance with the requirements of the following regulations:

EN 55022: CLASS B

RoHS

All contents of this package, including products, packing materials and documentation comply with RoHS.



© 2009 by Green-Box

Green-Box Technology Co. Ltd. reserves the right to make changes in the hardware, packaging, and any accompanying documentation without prior written notice.

No part of this document may be reproduced or transmitted in any form or by any means, electronic, mechanical, photocopying, recording, or otherwise, without prior written permission of Green-Box Technology Co. Ltd.

1. Product Introduction

AVE-300 series is a broadcast system to transmit Audio and Video signals over Cat5/5e/6 cable, it can reach the distance up to 300m and by stacking more system Transceivers, the whole system can extend AV signals up to 900m. You can use different cable kit to broadcast VGA, Component, Composite, or S-video from multimedia output devices. The video quality can be adjusted very easily from the FOCUS and GAIN Control in the Receiver. It can simplify the installation by using single Cat5/5e/6 cable and reach a longer distance; the AV extender is a perfect extension solution for projector, plasma TV, LCD TV, LCD monitor, HDTV, and CRT, as well as in the area of Digital Signage broadcasting.

2. Product Features

- AVE-300 series can send Audio and Video signals from Transmitter over Cat5/5e/6 cable, and broadcast in Receiver. The broadcasting distance is 300 meters and by stacking more system transceivers, it can extend AV signals up to 900 meters.
- PC Cable Kit: used to carry VGA Video + Audio, support all VGA format and with a maximum capacity of 2048x1536@300m
- Remote and local monitors and speakers can broadcast simultaneously
- Use Cat5 Enhance UTP cable (350MHz bandwidth) for better video quality
- Receiver and Transceiver build in video gain and focus control to adjust the video quality
- Software free, pure hardware design, support Plug & Play
- Transmitter and Receiver build with LEDs to indicate system status
- Stackable capacity to expand the AV broadcasting
- Provides magnetic pad and attachable metal plate for single-port unit to ease the installation

3. System Devices & Function

■ **One-Port Transmitter AVE-301T:**

- (1) Built in one set of AV inputs
- (2) Built in one set of AV outputs to monitor the AV signal broadcasted
- (3) Built in one RJ-45 port for system output which can be connected by Cat5/5e/6 cable and send signal to System Receiver
- (4) Take the power from USB or power adaptor

■ **4 / 8 / 16-Port Transmitter AVE-304T, AVE-308T, AVE-316T:**

- (1) Built in one set of AV inputs
- (2) Built in one set of AV output to monitor the AV signal broadcasted
- (3) Built in 4/8/16 R-J45 ports for system output which can be connected by Cat5/5e/6 cable and send signal to 4/8/16 sets of System Receiver or Transceiver

■ **Receiver AVE-301R:**

- (1) Receive AV signal through RJ45 port, and with video and focus control, you can adjust the video quality, the maximum supported extended VGA resolution and distance up to 2048x1536@300m
- (2) Built in one set of AV outputs (VGA + Audio) to display the AV signal broadcasted

4. Panel Descriptions

■ AVE-301T Single-Port AV Transmitter

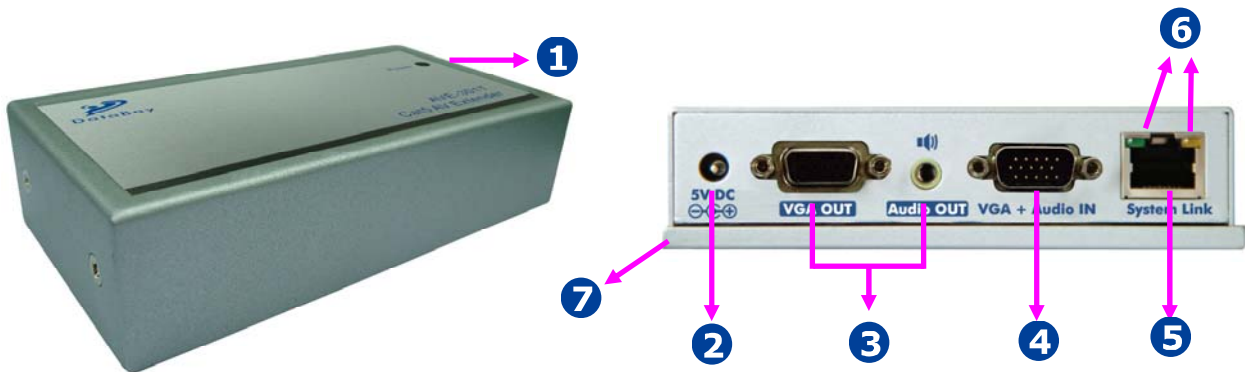

- 1** Power Indicator
- 2** Power Jack
- 3** VGA + Audio Output
- 4** VGA + Audio + USB Power Input
- 5** RJ-45 AV Output
- 6** H & V Sync Activity
- 7** Magnetic Pad

■ AVE-301R Single-Port AV Receiver

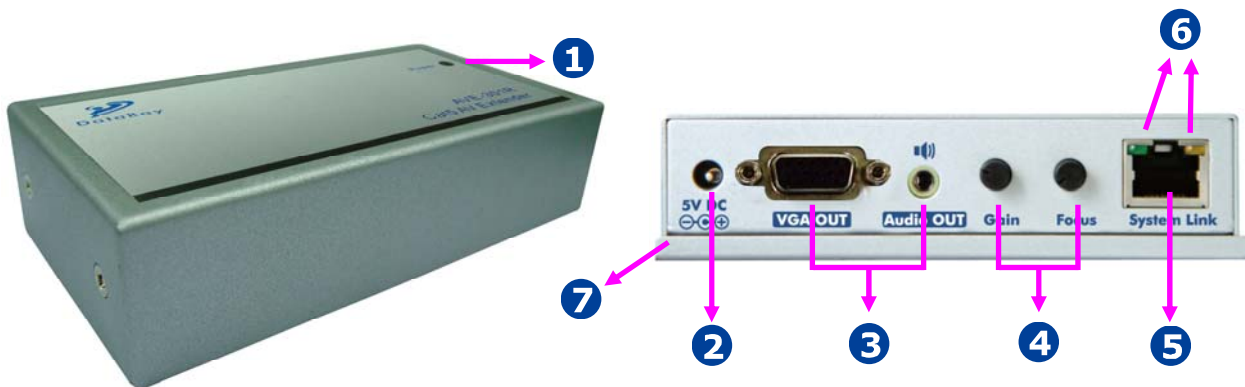

- 1** Power Indicator
- 2** Power Jack
- 3** VGA + Audio Output
- 4** Video Control
- 5** RJ-45 AV Input
- 6** H & V Sync Activity
- 7** Magnetic Pad

■ AVE-304T / AVE-308T / AVE-316T Multi-Port AV Transmitter

- AVE-304T

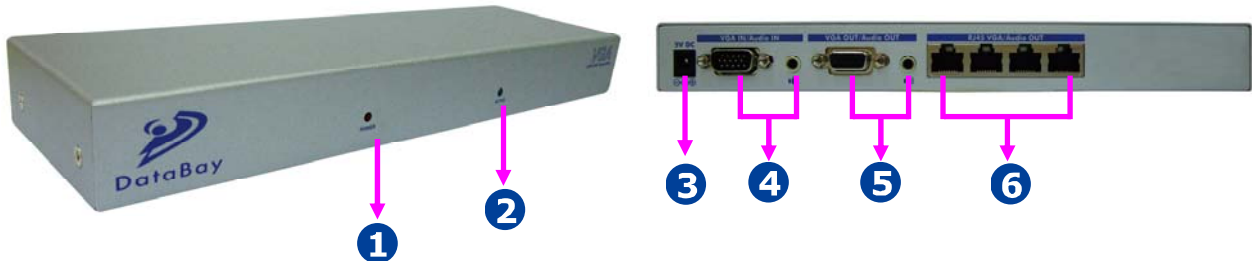

- AVE-308T

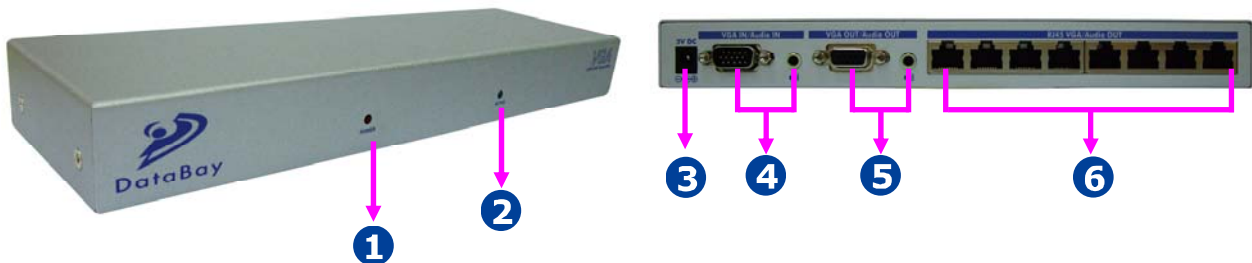

- AVE-316T

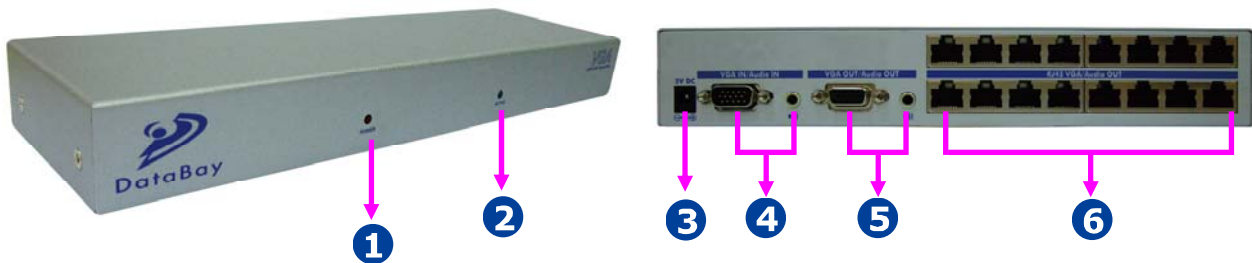

1 VGA Activity

3 Power Jack

5 VGA + Audio Output

2 Power Indicator

4 VGA + Audio Input

6 RJ-45 AV Output

■ **Cable and Accessories**

3-in-1 AVU cable for AVE-301T



VGA cable 1M & Audio cable 1.2M for
AVE-304T, AVE-308T, AVE-316T



PC cable kit for VGA Video + Audio

5. Installation and Operation

AVE-300 series supports different video format by using different cable kit. Section 1 will describe how to extend VGA and Audio signals by PC cable kit and in Section 2 & 3, you should find the description of how to use HDTV and TV cable kit to extend Component, Composite, and S-Video

■ Extend VGA Video and Audio by PC Cable Kit

5.1 AVE-301T Single-Port Transmitter Installation:

- (1) **Site Selection:** In your first time installation, place Transmitter near the PC or AV devices (Audio and Video outputs); you can use magnetic pad to attach the unit on metal plane (Ex. PC / Server Enclosure) or use attachable rack mounting kit to fix the unit on selected area by screw or nail.



Unit attached with Wall Mounting Kit

- (2) **Connecting Monitor and Speaker:** Take a 3-in-1 cable (VGA + Audio + USB Power) to connect the signal from your AV device to the "GA+AUDIO IN" port of Transmitter box and then connect monitor and peaker to the "VGA OUT" and "AUDIO" ports. The Transmitter can ake the power through the USB port or if you are using DVD Player or other devices without USB port, you can plug optional power adaptor DC 5V, 1A).

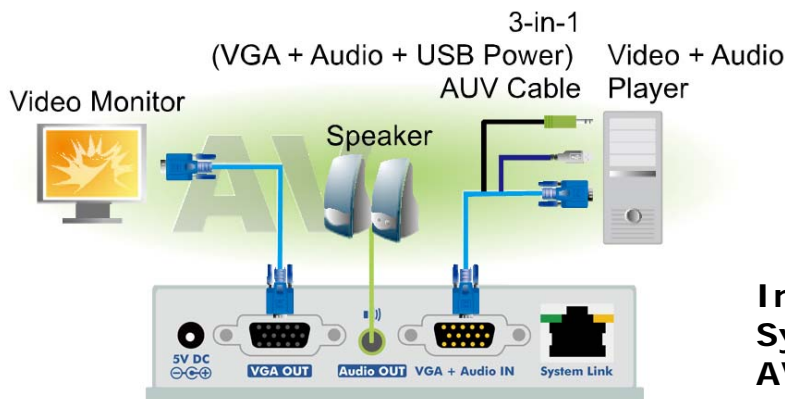

Installation Diagram of System Transmitter AVE-301T

One Port Transmitter

- (3) **Function Test:** Turn on your AV device, the POWER LED should turn on green to indicate the Power On status and the LEDs above RJ-45 will blink before VGA signal is turned On and remain On after VGA signal is turned On.

5.2 Receiver AVE-301R installation and UTP Connection:

- (1) **Site Selection:** Please place Receiver in an appropriate place and have the UTP cable settled for later connection; you can use magnetic pad to attach the unit on metal plane or use attachable rack mounting kit to fix the unit on selected area by screw or nail.
- (2) **Power Up:** Plug power adapter to the Receiver and connect monitor and speaker to the "VGA OUT" and "AUDIO" port. The POWER LED will turn on green to indicate the POWER ON status and the LED above RJ-45 port should blink to indicate the AV signal unconnected status.
- (3) **Selection of UTP Cable:** For best VGA resolution, please use Cat5 Enhanced cable (350MHz bandwidth) for connection, please noted that the maximum extended length of one section (one pair of Transmitter or Receiver) should not exceed 300 meters. The connector must be made by 568B/568B type.

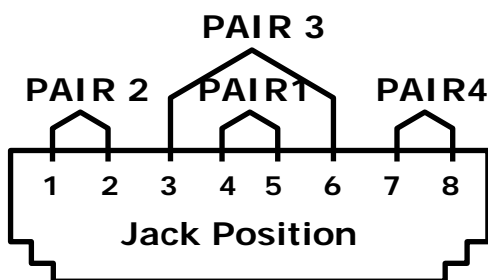

The EIA/TIA definition of 568B in the pin assignment is (1)orange white, (2)orange, (3)green white, (4)blue, (5)blue white, (6)green, (7)brown white, and (8)brown.

- (4) **Connect UTP Cable:**

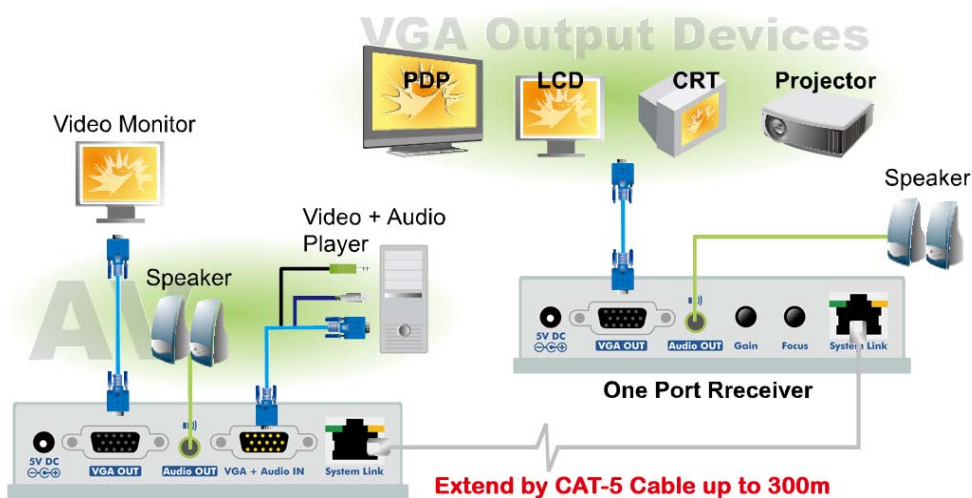

One Port Transmitter

Installation Diagram of Receiver AVE-301R

Plug two ends of UTP cable to Transmitter and Receiver's RJ45 SYSTEM LINK ports, the Receiver's connected monitor and speaker should work now and the LEDs above RJ-45 port should remain ON. You can adjust the "FOCUS" and "GAIN" control of Receiver to have the best VGA display.

- (5) **Function Test:** After above installation, you will be able to broadcast the AV signal to Receiver's connected monitor and speaker.
- (6) **Problem and Solving:** If you find unstable image or audio problems after installation, please confirm following list or contact your direct vendor for further assistance:
- a. Check if PC's VGA resolution and frequency over the limit of monitor display, if so, please change the VGA configuration from Windows Control panel.
 - b. Try to connect Monitor and speaker directly to a PC, and ensure the basic function of these devices.
 - c. When using LCD or same type monitor, there might have some image offset or blinking, please adjust the position, clock or phase of the LCD monitor, or simply press Auto Adjust / Tune to have a better image solution.

5.3 AVE-300 Multi-Port Model: Installation and Operation:

- (1) **Site Selection:** In your first time installation, place Transmitter near the PC or AV devices; you can use rack mounting kit to fix the system box.



Rack Mounting Kit for Multi-Port Unit

- (2) **Connecting Monitor and Speaker:** Plug power adapter to the Transmitter and connect monitor and speaker to "VGA/AUDIO OUT" port. The POWER LED will turn on green to indicate the POWER ON status and "ACTIVE" LEDs should turn off to indicate the unconnected status. Then, prepare VGA and audio cables to connect the signal from your AV device to the "VGA/AUDIO IN" port of Transmitter box.

- (3) **Local Function Test:** Power on your AV device, the "ACTIVE" LEDs of Transmitter will turn on orange to indicate the video activation, and you should be ready to do AV broadcasting.

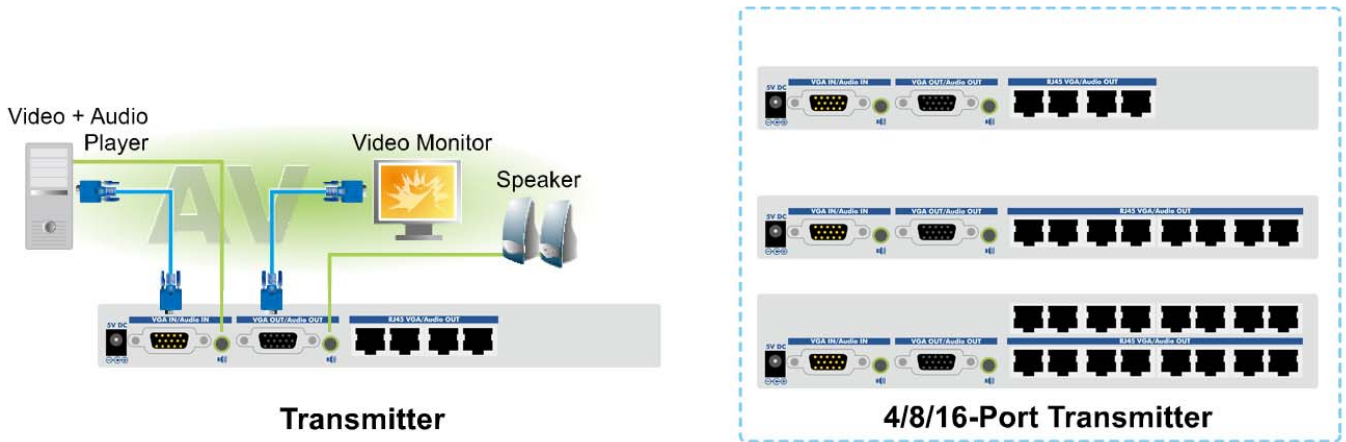

Installation Diagram of System Transmitter

- (4) **Receiver Installation:** Please follow previous section for AVE-301R to install the system Receiver, please note that the maximum extended length of this section should not exceed 300 meters.

- (5) **Local System Expansion:** You can also stack up to 3 layers of system Transceiver to generate more RJ-45 outputs of AV signal locally, please refer to following diagram.

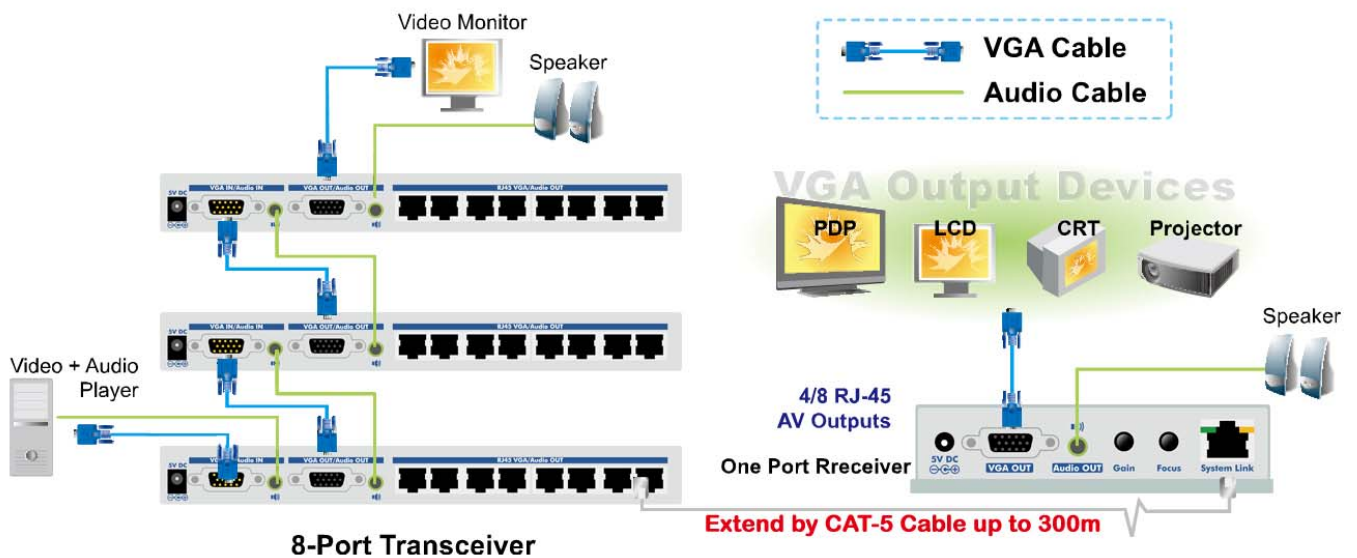

6. Specifications

Model Name	AV Transmitter				AV Receiver
Model No.	AVE -301T	AVE- 304T	AVE -308T	AVE -316T	AVE -301R
AV Output	AV x 1 RJ45 x1	AV x 1 RJ45 x4	AV x 1 RJ45 x8	AV x 1 RJ45 x16	AV x 1 RJ45 x1
AV Input	AV x 1				RJ45 x1
Audio	Stereo				Mono
PC Cable Kit used to Deliver VGA Video + Audio	AVU cable for AVE-301T, VGA and Audio cable for AVE-304T, AVE-308T, and AVE-316T				-
Video CTRL	-				Video Gain and Focus
LED	Power and Activity				
Video Quality	PC: Support all VGA format and with a maximum capacity of 2048x1536@300m				
Power Consumption	DC 5V, 1A	DC 5V, 2.6A			DC 5V, 1A
Dimension (LxWxH)	62 x 113 x 29mm	247 x 70 x 28mm		247 x 70 x 44mm	62 x 113 x 29mm
Environmental Condition	<ul style="list-style-type: none"> • Operation Temp.: 0~50° C • Storage Temp.: -20~60° C • Humidity: 10~90% 				

7. Order Information

Order Details	Part Number	Remark
One Port AVE-300 AV Transmitter	AVE-301T	DC 5V Power Adaptor x 1, AVU Cable Kit x 1 Wall-mount Kit x 1
4-Port AVE-300 AV Transmitter	AVE-304T	DC5V Power Adaptor x 1, Audio Cable Kit x 1 VGA Cable x 1 Rack-mount Kit x 1
8-Port AVE-300 AV Transmitter	AVE-308T	DC5V Power Adaptor x 1, Audio Cable Kit x 1 VGA Cable x 1 Rack-mount Kit x 1
16-Port AVE-300 AV Transmitter	AVE-316T	DC5V Power Adaptor x 1, Audio Cable Kit x 1 VGA Cable x 1 Rack-mount Kit x 1
One Port AVE-300 AV Receiver	AVE-301R	DC 5V Power Adaptor x 1, Wall-mount Kit x 1
PC Cable Kit for VGA and Audio		
For AVE-301T	AVU cable x 1	
AVE-304T, AVE-308T, AVE-316T	VGA cable x 1	
For AVE-301R	n/a	

8. Remarks

- I. Before operating this system, please read operation manual carefully.
- II. Please use correct power adapter and use high quality cable for optimum broadcasting.
- III. To prevent potential power damage, please don't use 2 -wire extension cord and ensure AC outlets at relative devices on the same electronic phase and have correct grounding.
- IV. Limited Warranty:
 - (1) In no events shall the vendor's liability for direct or indirect, special, incidental or consequential damages, loss of profit, loss of business, or financial loss which may be caused by the use of the product exceeds the price paid for the product.
 - (2) The vendor makes no warranty or representation, expressed or implied with respect to the contents or use of this documentation, and especially disclaims its quality, performance, merchantability, or fitness for any particular purpose.
 - (3) The vendor also reserves the right to revise or update the product or documentation without obligation to notify any user of such revisions or updates. For further information please contact your vendor.

9. Notice

1. All other company or product names mentioned herein are trademarks or registered trademarks of their respective companies.
2. Specifications are subject to change without notice.
3. Please read user manual carefully before operating the device
4. Please use the power adaptor accompanied with this product. Warranty does not cover for damages caused by pairing other power adaptor
5. Please check all connecting devices are properly grounded to avoid electric failure
6. This product has limited warranty for one year from defects in material and workmanship. Items that are physically damaged, misused, tempered with or altered are void of warranty. For further details please contact your distributor. In case warranty sticker is damaged or missing, warranty is void. For further details please contact your distributor.

P/N: CDDMAVE30000A1